



NP2 Série de Dispositivo Piloto

1. Informação Geral

Classificação elétrica: CA50/60Hz, CA400V/CC220V;
Grau de Proteção: IP40
Padrão: IEC/EN60947-5-1

	EUA	
	Rússia	
	UE	

2. Condições de Trabalho e Montagem

- 2.1 Temperatura ambiente entre $-5^{\circ}\text{C} \sim +40^{\circ}\text{C}$, a temperatura média em 24h não pode ser superior a $+35^{\circ}\text{C}$;
- 2.2 Altitude: $\leq 2000\text{m}$.
- 2.3 Condições Atmosféricas: A umidade relativa do ar não deve ultrapassar 50% quando a temperatura mais alta for $+40^{\circ}\text{C}$; umidade relativa muito mais alta pode ser permitida com a condição que a temperatura seja mais baixa, por exemplo, quando a temperatura está em $+20^{\circ}\text{C}$, a umidade relativa pode ser de até 90%.
Quanto ao orvalho, que aparece eventualmente devido a mudanças da temperatura, devem ser tomadas medidas especiais.
- 2.4 Grau de poluição: 3
- 2.5 Categoria de Sobrevoltagem: II

3. Informações Técnicas

- 3.1 Tensão nominal de isolamento Ui: 400V
- 3.2 Corrente térmica convencional Ith: 10A

Tensão nominal de serviço Ue (V)	Corrente nominal operacional Ie (A)	
	CA-15	CC-13
415	1,9	-
240	3	0,27
125	-	0,55

3.3 Durabilidade

Vida elétrica: Tipo cabeça embutida e cabeça cogumelo: CA 5×10^5 círculos de operação, CC 2×10^5 círculos de operação; outros tipos: 1×10^5 círculos de operação;
Vida mecânica: tipo cabeça embutida e cabeça cogumelo: 1 milhão de círculos de operação, botão com luz: 3×10^5 círculos de operação; outros tipos: 1×10^5 círculos de operação;

4. Dados das lâmpadas do botão iluminado

Parâmetros básicos	Tipo direto				
	Lâmpada incandescente			Lâmpada de neon	Lâmpada LED
Fornecimento de energia potência nominal Pe ou corrente nominal operacional Ie	Pe $\leq 1\text{W}$	Pe $\leq 1,2\text{W}$	Pe $\leq 1,5\text{W}$	Ie $\leq 2,5\text{mA}$	Ie $\leq 20\text{mA}$
Tensão nominal de serviço (V)	CA/CC6	CA/CC12	CA/CC24, 48	CA/CC 110, 230, 400	CA/CC 6, 12, 24, 48, 110, 230
Parâmetros básicos do fornecimento de energia	Tipo do transformador				
Suprimento de energia potência nominal Pe	Lâmpada incandescente 6V			Lâmpada LED 6V	
fornecimento de energia corrente nominal operacional Ie	Pe $\leq 1\text{W}$			Ie $\leq 20\text{mA}$	
Tensão nominal de serviço (V)	CA/CC 230, 400				

Dispositivo Piloto

5. Características

- 5.1 Não é possível a desmontagem do botão a partir da parte frontal por causa da peça operacional antimovimento do botão do tipo metálico;
- 5.2 Contatos confiáveis devem ser garantidos por causa da função dupla de alternância de circuitos e autolimpeza de todos os pontos de contato;
- 5.3 Os conjuntos de contato NF e NA são independentes um do outro e podem ser combinados livremente para a conveniente substituição;
- 5.4 Terminais de conexão ocultos tornam a operação segura e confiável.
Aparência elegante como resultado da adoção da liga de alumínio e zinco nas partes operacionais e base do botão do tipo metálico;
- 5.5 Assim como no botão iluminado, a luz indicadora adota a base de luz BA9s, tipos diferentes de lâmpadas podem ser escolhidos em várias solicitações.

6. Dispositivo Piloto NP2 (Plano de Perfuração ϕ 22,3)

★ Botão de apertar Embutido Temporário (Não-iluminado)

NP2-BA □□	Modelo	Cor		
	NP2-BA11	○	1	—
	NP2-BA21	●	1	—
	NP2-BA31	●	1	—
	NP2-BA41	●	1	—
	NP2-BA51	●	1	—
	NP2-BA61	●	1	—
	NP2-BA12	○	—	1
	NP2-BA22	●	—	1
	NP2-BA32	●	—	1
	NP2-BA42	●	—	1
	NP2-BA52	●	—	1
	NP2-BA62	●	—	1

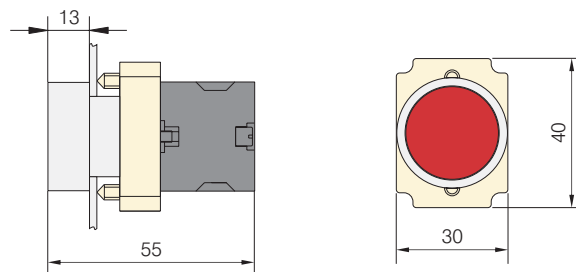

NP2-BA □□	Modelo	Cor		
	NP2-BA13	○	2	—
	NP2-BA23	●	2	—
	NP2-BA33	●	2	—
	NP2-BA43	●	2	—
	NP2-BA53	●	2	—
	NP2-BA63	●	2	—
	NP2-BA14	○	—	2
	NP2-BA24	●	—	2
	NP2-BA34	●	—	2
	NP2-BA44	●	—	2
	NP2-BA54	●	—	2
	NP2-BA64	●	—	2
	NP2-BA15	○	1	1
	NP2-BA25	●	1	1
	NP2-BA35	●	1	1
	NP2-BA45	●	1	1
	NP2-BA55	●	1	1
	NP2-BA65	●	1	1

Dimensões (mm)



NP2-BA □□

★ Botão de apertar Embutido Temporário (Iluminado)

NP2-BW □□	Voltagem da Lâmpada	Modelo	Cor	↵	↶
	LED : CA 6V, 12V, 24V, 36V, 48V, 110V, 230V	NP2-BW3161 (LED)	○	1	—
		NP2-BW3361 (LED)	●	1	—
		NP2-BW3461 (LED)	●	1	—
		NP2-BW3561 (LED)	●	1	—
		NP2-BW3661 (LED)	●	1	—
		NP2-BW3162 (LED)	○	—	1
		NP2-BW3362 (LED)	●	—	1
		NP2-BW3462 (LED)	●	—	1
		NP2-BW3562 (LED)	●	—	1
	NEON : CA 110V, 230V, 400V	NP2-BW3161 (NEON)	○	1	—
		NP2-BW3361 (NEON)	●	1	—
		NP2-BW3461 (NEON)	●	1	—
		NP2-BW3561 (NEON)	●	1	—
		NP2-BW3661 (NEON)	●	1	—
		NP2-BW3162 (NEON)	○	—	1
		NP2-BW3362 (NEON)	●	—	1
		NP2-BW3462 (NEON)	●	—	1
		NP2-BW3562 (NEON)	●	—	1
	INCANDESCENTE: CA 6V, 12V, 24V, 36V, 48V	NP2-BW3161 (INCA)	○	1	—
		NP2-BW3361 (INCA)	●	1	—
		NP2-BW3461 (INCA)	●	1	—
		NP2-BW3561 (INCA)	●	1	—
		NP2-BW3661 (INCA)	●	1	—
		NP2-BW3162 (INCA)	○	—	1
		NP2-BW3362 (INCA)	●	—	1
		NP2-BW3462 (INCA)	●	—	1
		NP2-BW3562 (INCA)	●	—	1
	LED : CA 6V, 12V, 24V, 36V, 48V, 110V, 230V	NP2-BW3163 (LED)	○	2	—
		NP2-BW3363 (LED)	●	2	—
		NP2-BW3463 (LED)	●	2	—
		NP2-BW3563 (LED)	●	2	—
		NP2-BW3663 (LED)	●	2	—
		NP2-BW3164 (LED)	○	—	2
		NP2-BW3364 (LED)	●	—	2
		NP2-BW3464 (LED)	●	—	2
		NP2-BW3564 (LED)	●	—	2
		NP2-BW3664 (LED)	●	—	2

Dispositivo Piloto

NP2-BW □ □	Voltagem da Lâmpada	Modelo	Cor	1	2
	LED : CA 6V, 12V, 24V, 36V, 48V, 110V, 230V	NP2-BW3165 (LED)	○	1	1
		NP2-BW3365 (LED)	●	1	1
		NP2-BW3465 (LED)	●	1	1
		NP2-BW3565 (LED)	●	1	1
		NP2-BW3665 (LED)	●	1	1
	NEON : CA 110V, 230V, 400V	NP2-BW3163 (NEON)	○	2	—
		NP2-BW3363 (NEON)	●	2	—
		NP2-BW3463 (NEON)	●	2	—
		NP2-BW3563 (NEON)	●	2	—
		NP2-BW3663 (NEON)	●	2	—
		NP2-BW3164 (NEON)	○	—	2
		NP2-BW3364 (NEON)	●	—	2
		NP2-BW3464 (NEON)	●	—	2
		NP2-BW3564 (NEON)	●	—	2
		NP2-BW3664 (NEON)	●	—	2
		NP2-BW3165 (NEON)	○	1	1
		NP2-BW3365 (NEON)	●	1	1
		NP2-BW3465 (NEON)	●	1	1
		NP2-BW3565 (NEON)	●	1	1
		NP2-BW3665 (NEON)	●	1	1
	INCANDESCENTE: CA 6V, 12V, 24V, 36V, 48V	NP2-BW3163 (INCA)	○	2	—
		NP2-BW3363 (INCA)	●	2	—
		NP2-BW3463 (INCA)	●	2	—
		NP2-BW3563 (INCA)	●	2	—
		NP2-BW3663 (INCA)	●	2	—
		NP2-BW3164 (INCA)	○	—	2
		NP2-BW3364 (INCA)	●	—	2
		NP2-BW3464 (INCA)	●	—	2
		NP2-BW3564 (INCA)	●	—	2
		NP2-BW3664 (INCA)	●	—	2
		NP2-BW3165 (INCA)	○	1	1
		NP2-BW3365 (INCA)	●	1	1
		NP2-BW3465 (INCA)	●	1	1
		NP2-BW3565 (INCA)	●	1	1
		NP2-BW3665 (INCA)	●	1	1

Dimensões (mm)

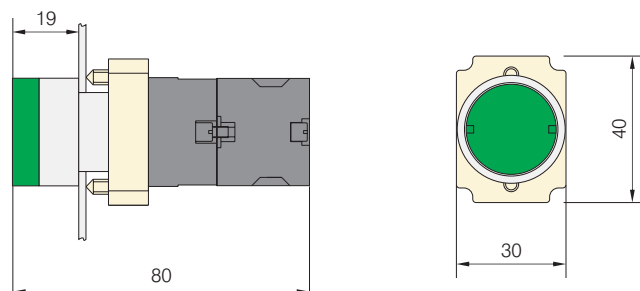

NP2-BW 3 □ 6 □

★ Botão de apertar Embutido Temporário (Iluminado)-(Tipo do transformador) Botão de apertar Embutido Temporário (Iluminado)-(Tipo do transformador)

NP2-BW □□	Voltagem da Lâmpada	Modelo	Cor	1	1
		NP2-BW3141	○	1	—
		NP2-BW3341	●	1	—
		NP2-BW3441	●	1	—
		NP2-BW3541	●	1	—
		NP2-BW3641	●	1	—
		NP2-BW3142	○	—	1
		NP2-BW3342	●	—	1
		NP2-BW3442	●	—	1
		NP2-BW3542	●	—	1
		NP2-BW3642	●	—	1
	(Tipo do Transformador) INCANDESCENTE: CA 230V & LED: CA 230V	NP2-BW3143	○	2	—
		NP2-BW3343	●	2	—
		NP2-BW3443	●	2	—
		NP2-BW3543	●	2	—
		NP2-BW3643	●	2	—
		NP2-BW3144	○	—	2
		NP2-BW3344	●	—	2
		NP2-BW3444	●	—	2
		NP2-BW3544	●	—	2
		NP2-BW3644	●	—	2
		NP2-BW3145	○	1	1
		NP2-BW3345	●	1	1
		NP2-BW3445	●	1	1
		NP2-BW3545	●	1	1
		NP2-BW3645	●	1	1
	(Tipo do Transformador) INCANDESCENTE: CA 400V & LED: CA 400V	NP2-BW3151	○	1	—
		NP2-BW3351	●	1	—
		NP2-BW3451	●	1	—
		NP2-BW3551	●	1	—
		NP2-BW3651	●	1	—
		NP2-BW3152	○	—	1
		NP2-BW3352	●	—	1
		NP2-BW3452	●	—	1
		NP2-BW3552	●	—	1
NP2-BW3652	●	—	1		

Dispositivo Piloto

NP2-BW □□	Voltagem da Lâmpada	Modelo	Cor	↙	↘
 (Tipo do Transformador) INCANDESCENTE: CA 400V & LED: CA 400V		NP2-BW3153	○	2	—
		NP2-BW3353	●	2	—
		NP2-BW3453	●	2	—
		NP2-BW3553	●	2	—
		NP2-BW3653	●	2	—
		NP2-BW3154	○	—	2
		NP2-BW3354	●	—	2
		NP2-BW3454	●	—	2
		NP2-BW3554	●	—	2
		NP2-BW3654	●	—	2
		NP2-BW3155	○	1	1
		NP2-BW3355	●	1	1
		NP2-BW3455	●	1	1
		NP2-BW3555	●	1	1
		NP2-BW3655	●	1	1

Dimensões (mm)

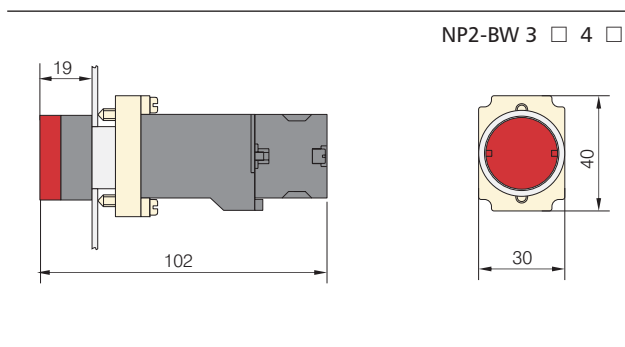

★ φ 40 Botão cabeça Cogumelo Temporário (não-iluminado)

NP2-BC □□	Modelo	Cor	↙	↘
	NP2-BC11	○	1	—
	NP2-BC21	●	1	—
	NP2-BC31	●	1	—
	NP2-BC41	●	1	—
	NP2-BC51	●	1	—
	NP2-BC61	●	1	—
	NP2-BC12	○	—	1
	NP2-BC22	●	—	1
	NP2-BC32	●	—	1
	NP2-BC42	●	—	1
	NP2-BC52	●	—	1
	NP2-BC62	●	—	1

NP2-BC □□	Modelo	Cor	↙	↘
	NP2-BC13	○	2	—
	NP2-BC23	●	2	—
	NP2-BC33	●	2	—
	NP2-BC43	●	2	—
	NP2-BC53	●	2	—
	NP2-BC63	●	2	—
	NP2-BC14	○	—	2
	NP2-BC24	●	—	2
	NP2-BC34	●	—	2
	NP2-BC44	●	—	2
	NP2-BC54	●	—	2
	NP2-BC64	●	—	2
	NP2-BC15	○	1	1
	NP2-BC25	●	1	1
	NP2-BC35	●	1	1
	NP2-BC45	●	1	1
	NP2-BC55	●	1	1
	NP2-BC65	●	1	1

★ ϕ 60 Botão cabeça Cogumelo Temporário (não-iluminado)

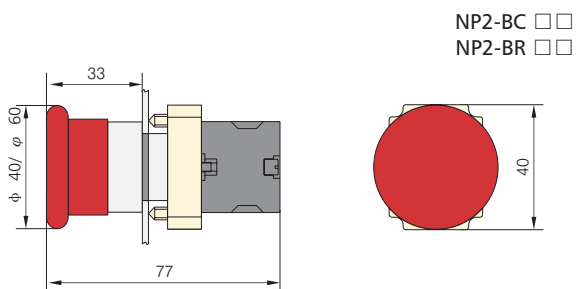

NP2-BR □□	Modelo	Cor	↙	↘
	NP2-BR11	○	1	—
	NP2-BR21	●	1	—
	NP2-BR31	●	1	—
	NP2-BR41	●	1	—
	NP2-BR51	●	1	—
	NP2-BR61	●	1	—
	NP2-BR12	○	—	1
	NP2-BR22	●	—	1
	NP2-BR32	●	—	1
	NP2-BR42	●	—	1
	NP2-BR52	●	—	1
	NP2-BR62	●	—	1

Dimensões (mm)



NP2-BR □□	Modelo	Cor	↙	↘
	NP2-BR13	○	2	—
	NP2-BR23	●	2	—
	NP2-BR33	●	2	—
	NP2-BR43	●	2	—
	NP2-BR53	●	2	—
	NP2-BR63	●	2	—
	NP2-BR14	○	—	2
	NP2-BR24	●	—	2
	NP2-BR34	●	—	2
	NP2-BR44	●	—	2
	NP2-BR54	●	—	2
	NP2-BR64	●	—	2
	NP2-BR15	○	1	1
	NP2-BR25	●	1	1
	NP2-BR35	●	1	1
	NP2-BR45	●	1	1
	NP2-BR55	●	1	1
	NP2-BR65	●	1	1

★ Botão embutido de cabeça dupla temporário (Não-iluminado)

NP2-BL8 □□	Voltagem da Lâmpada	Modelo	Cor	↙	↘
	-----	NP2-BL8325	● + ●	1	1
	-----	NP2-BL8425	● + ●	1	1

Dimensões (mm)

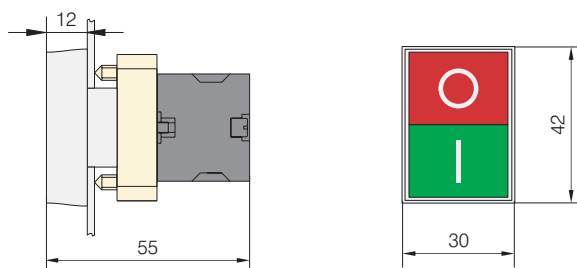

NP2-BL8325

Dispositivo Piloto

★ Botão embutido de cabeça dupla temporário (Iluminado)

NP2-BW8 □ □	Voltagem da Lâmpada	Modelo	Cor	↙	↘
	LED : CA 6V, 12V, 24V, 36V, 48V, 110V, 230V	NP2-BW8465	●+●	1	1
	NEON : CA 110V, 230V, 400V	NP2-BW8465	●+●	1	1
	INCANDESCENTE: CA 6V, 12V, 24V, 36V, 48V	NP2-BW8465	●+●	1	1
	Tipo do transformador: INCANDESCENTE: CA 230V & LED: CA 230V	NP2-BW8445	●+●	1	1
	Tipo do transformador: INCANDESCENTE: CA 400V & LED: CA 400V	NP2-BW8455	●+●	1	1

Dimensões (mm)

NP2-BW 8 □ 4 □

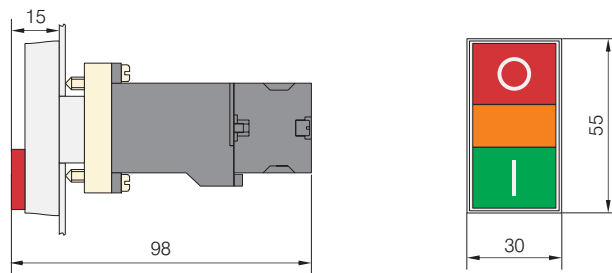

★ Botão cogumelo (Botão de Parada de Emergência)-(Não-iluminado)

NP2-BS □ □	Diâmetro do Cogumelo	Modelo	Cor	↙	↘
	φ 30	NP2-BS441	●	1	—
		NP2-BS442		—	1
	φ 40	NP2-BS541		1	—
		NP2-BS542		—	1
	φ 60	NP2-BS641		1	—
		NP2-BS642		—	1
	φ 30	NP2-BS443	●	2	—
		NP2-BS444		—	2
		NP2-BS445		1	1
	φ 40	NP2-BS543		2	—
		NP2-BS544		—	2
		NP2-BS545		1	1
	φ 60	NP2-BS643		2	—
		NP2-BS644		—	2
		NP2-BS645		1	1

Dimensões (mm)

NP2-BS □□□

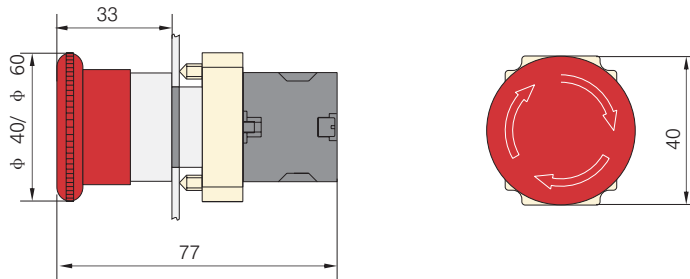

★ Indicador

NP2-BV □□	Voltagem da Lâmpada	Modelo	Cor
	LED : CA 6V, 12V, 24V, 36V, 48V, 110V, 230V	NP2-BV61	○
		NP2-BV63	●
		NP2-BV64	●
		NP2-BV65	●
		NP2-BV66	●
		NP2-BV66	●
	NEON : CA 110V, 230V, 380V	NP2-BV61	○
		NP2-BV63	●
		NP2-BV64	●
		NP2-BV65	●
		NP2-BV66	●
		NP2-BV66	●
	INCANDESCENTE: CA 6V, 12V, 24V, 36V, 48V	NP2-BV61	○
		NP2-BV63	●
		NP2-BV64	●
		NP2-BV65	●
		NP2-BV66	●
		NP2-BV66	●

NP2-BV □□	Voltagem da Lâmpada	Modelo	Cor
	INCANDESCENTE: CA 6V & LED: CA 6V	NP2-BV41	○
		NP2-BV43	●
	Transformador: 230V	NP2-BV44	●
		NP2-BV45	●
	INCANDESCENTE: CA 6V & LED: CA 6V	NP2-BV46	●
		NP2-BV51	○
	Transformador: 380V	NP2-BV53	●
		NP2-BV54	●
	NP2-BV55	●	
	NP2-BV56	●	

Dimensões (mm)

NP2-BV 6 □

NP2-BV4(5) □

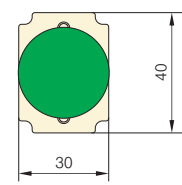
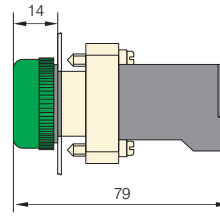
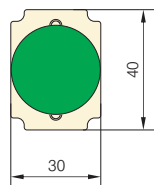
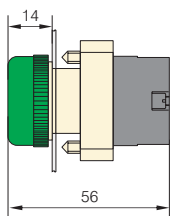

Dispositivo Piloto

★ Botões Seletores (2 posições)-(Não-iluminado)

NP2-BD (J, G) □□	Metal	Botões Seletores	↵	↶
	NP2-BD21		1	—
	NP2-BD22		—	1
	NP2-BD23		2	—
	NP2-BD24		—	2
	NP2-BD25		1	1
	NP2-BD41		1	—
	NP2-BD42		—	1
	NP2-BD43		2	—
	NP2-BD44		—	2
	NP2-BD45		1	1
	NP2-BJ21		1	—
	NP2-BJ22		—	1
	NP2-BJ23		2	—
	NP2-BJ24		—	2
	NP2-BJ25		1	1
	NP2-BJ41		1	—
	NP2-BJ42		—	1
	NP2-BJ43		2	—
	NP2-BJ44		—	2
	NP2-BJ45		1	1
	NP2-BG21		1	—
	NP2-BG22		—	1
	NP2-BG23		2	—
	NP2-BG24		—	2
	NP2-BG25		1	1
	NP2-BG21B		1	—
	NP2-BG22B		—	1
	NP2-BG23B		2	—
	NP2-BG24B		—	2
	NP2-BG25B		1	1
	NP2-BG41		1	—
	NP2-BG42		—	1
	NP2-BG43		2	—
	NP2-BG44		—	2
	NP2-BG45		1	1

★ Botões Seletores (3 posições)-(Não-iluminado)

NP2-BD (J, G) □□	Metal	Botões Seletores	↵	↶
	NP2-BD31		1	—
	NP2-BD32		—	1
	NP2-BD33		2	—
	NP2-BD34		—	2
	NP2-BD35		1	1
	NP2-BD51		1	—
	NP2-BD52		—	1
	NP2-BD53		2	—
	NP2-BD54		—	2
	NP2-BD55		1	1
	NP2-BJ31		1	—
	NP2-BJ32		—	1
	NP2-BJ33		2	—
	NP2-BJ34		—	2
	NP2-BJ35		1	1
	NP2-BJ51		1	—
	NP2-BJ52		—	1
	NP2-BJ53		2	—
	NP2-BJ54		—	2
	NP2-BJ55		1	1
	NP2-BG31		1	—
	NP2-BG32		—	1
	NP2-BG33		2	—
	NP2-BG34		—	2
	NP2-BG35		1	1
	NP2-BG51		1	—
	NP2-BG52		—	1
	NP2-BG53		2	—
	NP2-BG54		—	2
	NP2-BG55		1	1
	NP2-BG3B1D		1	—
	NP2-BG3B2D		—	1
	NP2-BG3B3D		2	—
	NP2-BG3B4D		—	2
	NP2-BG3B5D		1	1

Dimensões (mm)

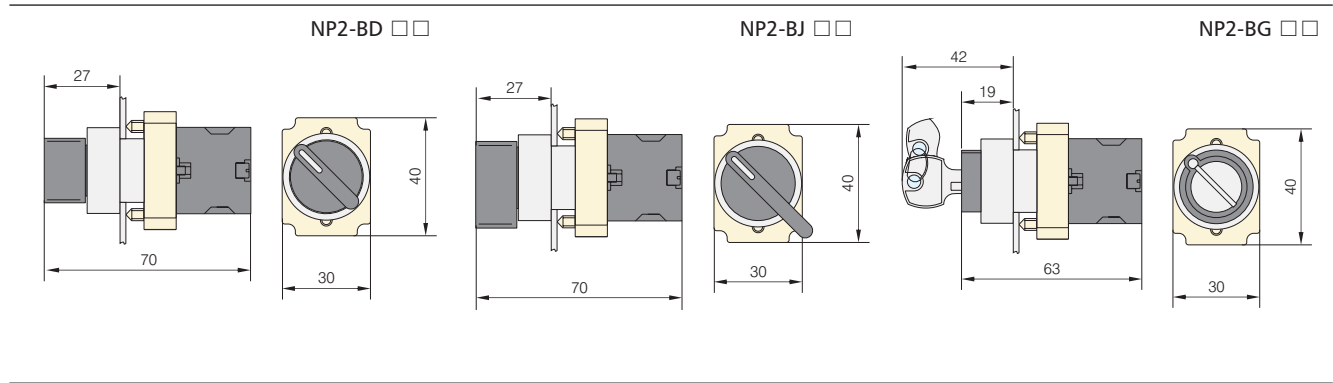

★ Botão de apertar Embutido Temporário (Não-iluminado)

NP2-EA □□	Modelo	Cor	Configuração	
			↙	↘
	NP2-EA11	○	1	—
	NP2-EA21	●	1	—
	NP2-EA31	●	1	—
	NP2-EA41	●	1	—
	NP2-EA51	●	1	—
	NP2-EA61	●	1	—
	NP2-EA12	○	—	1
	NP2-EA22	●	—	1
	NP2-EA32	●	—	1
	NP2-EA42	●	—	1
	NP2-EA52	●	—	1
	NP2-EA62	●	—	1

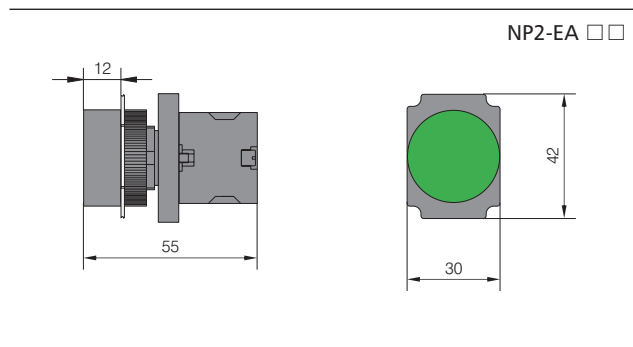

NP2-EA □□	Modelo	Cor	Configuração	
			↙	↘
	NP2-EA13	○	2	—
	NP2-EA23	●	2	—
	NP2-EA33	●	2	—
	NP2-EA43	●	2	—
	NP2-EA53	●	2	—
	NP2-EA63	●	2	—
	NP2-EA14	○	—	2
	NP2-EA24	●	—	2
	NP2-EA34	●	—	2
	NP2-EA44	●	—	2
	NP2-EA54	●	—	2
	NP2-EA64	●	—	2
	NP2-EA15	○	1	1
	NP2-EA25	●	1	1
	NP2-EA35	●	1	1
	NP2-EA45	●	1	1
	NP2-EA55	●	1	1
	NP2-EA65	●	1	1

Dimensões (mm)



Dispositivo Piloto

★ Botão de apertar Embutido Temporário (Iluminado)

NP2-EW3 □□	Voltagem da Lâmpada	Modelo	Cor	1	2
	LED : CA 6V, 12V, 24V, 36V, 48V, 110V, 230V	NP2-EW3161	○	1	—
		NP2-EW3361	●	1	—
		NP2-EW3461	●	1	—
		NP2-EW3561	●	1	—
		NP2-EW3661	●	1	—
		NP2-EW3162	○	—	1
		NP2-EW3362	●	—	1
		NP2-EW3462	●	—	1
		NP2-EW3562	●	—	1
	NEON : CA 110V, 230V, 400V	NP2-EW3161	○	1	—
		NP2-EW3361	●	1	—
		NP2-EW3461	●	1	—
		NP2-EW3561	●	1	—
		NP2-EW3661	●	1	—
		NP2-EW3162	○	—	1
		NP2-EW3362	●	—	1
		NP2-EW3462	●	—	1
		NP2-EW3562	●	—	1
INCANDESCENTE: CA 6V, 12V, 24V, 36V, 48V	NP2-EW3161	○	1	—	
	NP2-EW3361	●	1	—	
	NP2-EW3461	●	1	—	
	NP2-EW3561	●	1	—	
	NP2-EW3661	●	1	—	
	NP2-EW3162	○	—	1	
	NP2-EW3362	●	—	1	
	NP2-EW3462	●	—	1	
	NP2-EW3562	●	—	1	
	LED : CA 6V, 12V, 24V, 36V, 48V, 110V, 230V	NP2-EW3163	○	2	—
		NP2-EW3363	●	2	—
		NP2-EW3463	●	2	—
		NP2-EW3563	●	2	—
		NP2-EW3663	●	2	—
		NP2-EW3164	○	—	2
		NP2-EW3364	●	—	2
		NP2-EW3464	●	—	2
		NP2-EW3564	●	—	2
		NP2-EW3664	●	—	2

NP2-EW3 □ □	Voltagem da Lâmpada	Modelo	Cor	1	2
	LED : CA 6V, 12V, 24V, 36V, 48V, 110V, 230V	NP2-EW3165	○	1	1
		NP2-EW3365	●	1	1
		NP2-EW3465	●	1	1
		NP2-EW3565	●	1	1
		NP2-EW3665	●	1	1
	NEON : CA 110V, 230V, 400V	NP2-EW3163	○	2	—
		NP2-EW3363	●	2	—
		NP2-EW3463	●	2	—
		NP2-EW3563	●	2	—
		NP2-EW3663	●	2	—
		NP2-EW3164	○	—	2
		NP2-EW3364	●	—	2
		NP2-EW3464	●	—	2
		NP2-EW3564	●	—	2
		NP2-EW3664	●	—	2
		NP2-EW3165	○	1	1
		NP2-EW3365	●	1	1
		NP2-EW3465	●	1	1
	NP2-EW3565	●	1	1	
	NP2-EW3665	●	1	1	
	INCANDESCENTE: CA 6V, 12V, 24V, 36V, 48V	NP2-EW3163	○	2	—
		NP2-EW3363	●	2	—
		NP2-EW3463	●	2	—
		NP2-EW3563	●	2	—
		NP2-EW3663	●	2	—
		NP2-EW3164	○	—	2
		NP2-EW3364	●	—	2
		NP2-EW3464	●	—	2
		NP2-EW3564	●	—	2
		NP2-EW3664	●	—	2
		NP2-EW3165	○	1	1
		NP2-EW3365	●	1	1
		NP2-EW3465	●	1	1
NP2-EW3565		●	1	1	
NP2-EW3665		●	1	1	

Dimensões (mm)

NP2-EW 3 □ 6 □

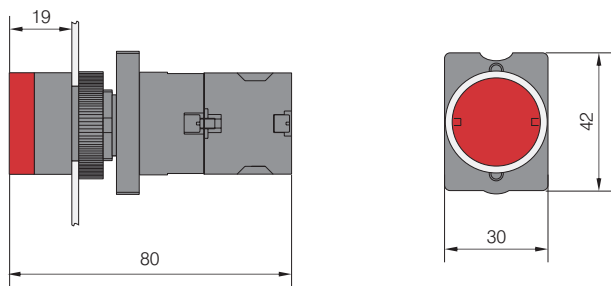

Dispositivo Piloto

★ Botão de apertar Embutido Temporário (tipo do transformador) (Iluminado)

NP2-EW3 □□	Voltagem da Lâmpada	Modelo	Cor	1	2
		NP2-EW3141	○	1	—
		NP2-EW3341	●	1	—
		NP2-EW3441	●	1	—
		NP2-EW3541	●	1	—
		NP2-EW3641	●	1	—
		NP2-EW3142	○	—	1
		NP2-EW3342	●	—	1
		NP2-EW3442	●	—	1
		NP2-EW3542	●	—	1
		NP2-EW3642	●	—	1
	Tipo do transformador: INCANDESCENTE: CA 230V & LED: CA 230V	NP2-EW3143	○	2	—
		NP2-EW3343	●	2	—
		NP2-EW3443	●	2	—
		NP2-EW3543	●	2	—
		NP2-EW3643	●	2	—
		NP2-EW3144	○	—	2
		NP2-EW3344	●	—	2
		NP2-EW3444	●	—	2
		NP2-EW3544	●	—	2
		NP2-EW3644	●	—	2
		NP2-EW3145	○	1	1
		NP2-EW3345	●	1	1
		NP2-EW3445	●	1	1
		NP2-EW3545	●	1	1
NP2-EW3645	●	1	1		
	Tipo do transformador: INCANDESCENTE: CA 400V & LED: CA 400V	NP2-EW3151	○	1	—
		NP2-EW3351	●	1	—
		NP2-EW3451	●	1	—
		NP2-EW3551	●	1	—
		NP2-EW3651	●	1	—
		NP2-EW3152	○	—	1
		NP2-EW3352	●	—	1
		NP2-EW3452	●	—	1
		NP2-EW3552	●	—	1
		NP2-EW3652	●	—	1
		NP2-EW3153	○	2	—
		NP2-EW3353	●	2	—
		NP2-EW3453	●	2	—
		NP2-EW3553	●	2	—
		NP2-EW3653	●	2	—

NP2-EW3 □ □	Voltagem da Lâmpada	Modelo	Cor	↘	↙
	Tipo do transformador: INCANDESCENTE: CA 400V & LED: CA 400V	NP2-EW3154	○	—	2
		NP2-EW3354	●	—	2
		NP2-EW3454	●	—	2
		NP2-EW3554	●	—	2
		NP2-EW3654	●	—	2
		NP2-EW3155	○	1	1
		NP2-EW3355	●	1	1
		NP2-EW3455	●	1	1
		NP2-EW3555	●	1	1
		NP2-EW3655	●	1	1

Dimensões (mm)

NP2-EW 3 □ 4 □

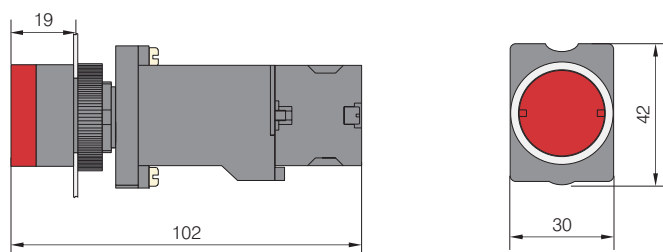



★ ϕ 40 Botão Cogumelo Temporário -(Não-iluminado)

NP2-EC □ □	Modelo	Cor	↘	↙
	NP2-EC11	○	1	—
	NP2-EC21	●	1	—
	NP2-EC31	●	1	—
	NP2-EC41	●	1	—
	NP2-EC51	●	1	—
	NP2-EC61	●	1	—
	NP2-EC12	○	—	1
	NP2-EC22	●	—	1
	NP2-EC32	●	—	1
	NP2-EC42	●	—	1
	NP2-EC52	●	—	1
	NP2-EC62	●	—	1

NP2-EC □ □	Modelo	Cor	↘	↙
	NP2-EC13	○	2	—
	NP2-EC23	●	2	—
	NP2-EC33	●	2	—
	NP2-EC43	●	2	—
	NP2-EC53	●	2	—
	NP2-EC63	●	2	—
	NP2-EC14	○	—	2
	NP2-EC24	●	—	2
	NP2-EC34	●	—	2
	NP2-EC44	●	—	2
	NP2-EC54	●	—	2
	NP2-EC64	●	—	2
	NP2-EC15	○	1	1
	NP2-EC25	●	1	1
	NP2-EC35	●	1	1
	NP2-EC45	●	1	1
	NP2-EC55	●	1	1
	NP2-EC65	●	1	1

★ ϕ 60 Botão Cogumelo Temporário -(Não-iluminado)

NP2-ER □□	Modelo	Cor	↙	↘
	NP2-ER11	○	1	—
	NP2-ER21	●	1	—
	NP2-ER31	●	1	—
	NP2-ER41	●	1	—
	NP2-ER51	●	1	—
	NP2-ER61	●	1	—
	NP2-ER12	○	—	1
	NP2-ER22	●	—	1
	NP2-ER32	●	—	1
	NP2-ER42	●	—	1
	NP2-ER52	●	—	1
	NP2-ER62	●	—	1

NP2-ER □□	Modelo	Cor	↙	↘
	NP2-ER13	○	2	—
	NP2-ER23	●	2	—
	NP2-ER33	●	2	—
	NP2-ER43	●	2	—
	NP2-ER53	●	2	—
	NP2-ER63	●	2	—
	NP2-ER14	○	—	2
	NP2-ER24	●	—	2
	NP2-ER34	●	—	2
	NP2-ER44	●	—	2
	NP2-ER54	●	—	2
	NP2-ER64	●	—	2
	NP2-ER15	○	1	1
	NP2-ER25	●	1	1
	NP2-ER35	●	1	1
	NP2-ER45	●	1	1
NP2-ER55	●	1	1	
NP2-ER65	●	1	1	

Dimensões (mm)

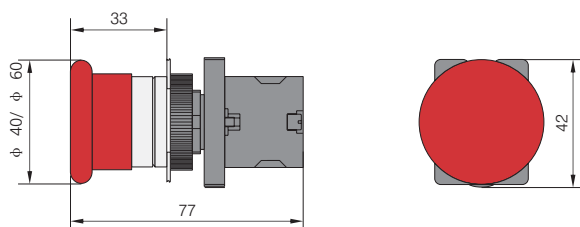

NP2-EC □□
 NP2-ER □□

★ Botão embutido de cabeça dupla temporário -(Não-iluminado)

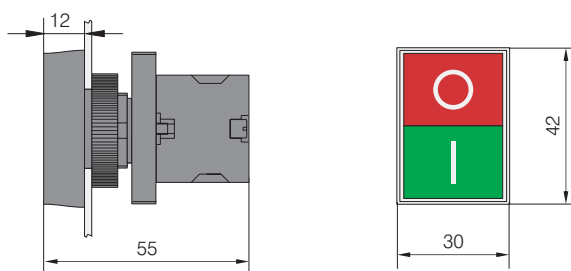

NP2-EL8 □□	Voltagem da Lâmpada	Modelo	Cor	↙	↘
	-----	NP2-EL8325	● + ●	1	1
	-----	NP2-EL8425	● + ●	1	1

Dimensões (mm)



NP2-EL8325

★ Botão embutido de cabeça dupla temporário (Iluminado)

NP2-BW8 □ □	Voltagem da Lâmpada	Modelo	Cor	↙	↘
	LED : CA 6V, 12V, 24V, 36V, 48V, 110V, 230V	NP2-EW8465	● + ●	1	1
	NEON : CA 110V, 230V, 400V	NP2-EW8465	● + ●	1	1
	INCANDESCENTE: CA 6V, 12V, 24V, 36V, 48V	NP2-EW8465	● + ●	1	1
	INCANDESCENTE: CA 6V & LED: CA 6V Transformador: 230V	NP2-EW8465	● + ●	1	1
	INCANDESCENTE: CA 6V & LED: CA 6V Transformador: 380V	NP2-EW8465	● + ●	1	1

Dimensões (mm)

NP2-EW 8 □ 6 □

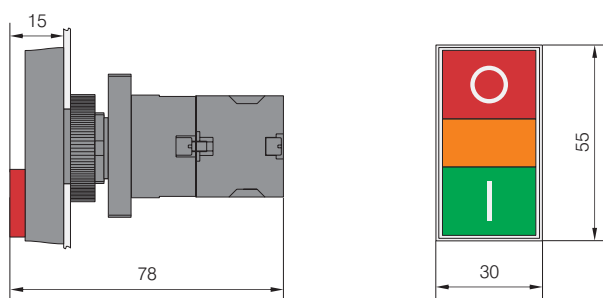

★ Botão cogumelo (Botão de Parada de Emergência)-(Não-iluminado)

NP2-ES □ □	Diâmetro do Cogumelo	Modelo	Cor	↙	↘
	φ 30	NP2-ES441	●	1	—
		NP2-ES442		—	1
	φ 40	NP2-ES541		1	—
		NP2-ES542		—	1
	φ 60	NP2-ES641		1	—
		NP2-ES642		—	1
	φ 30	NP2-ES443	●	2	—
		NP2-ES444		—	2
		NP2-ES445		1	1
	φ 40	NP2-ES543		2	—
		NP2-ES544		—	2
		NP2-ES545		1	1
	φ 60	NP2-ES643		2	—
		NP2-ES644		—	2
		NP2-ES645		1	1

Dimensões (mm)

NP2-ES □□□

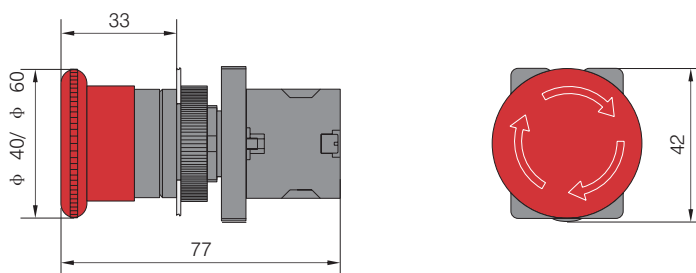

★ **Indicador**

NP2-EV □□	Voltagem da Lâmpada	Modelo	Cor
	LED : CA 6V, 12V, 24V, 36V, 48V, 110V, 230V	NP2-EV61	○
		NP2-EV63	●
		NP2-EV64	●
		NP2-EV65	●
		NP2-EV66	●
	NEON : CA 110V, 230V, 400V	NP2-EV61	○
		NP2-EV63	●
		NP2-EV64	●
		NP2-EV65	●
		NP2-EV66	●
	INCANDESCENTE: CA 6V, 12V, 24V, 36V, 48V	NP2-EV61	○
		NP2-BV63	●
		NP2-BV64	●
		NP2-BV65	●
		NP2-BV66	●

NP2-EV □□	Voltagem da Lâmpada	Modelo	Cor
	INCANDESCENTE: CA 6V & LED: CA 6V Transformador: 230V	NP2-EV41	○
		NP2-EV43	●
		NP2-EV44	●
		NP2-EV45	●
		NP2-EV46	●
		NP2-EV51	○
	INCANDESCENTE: CA 6V & LED: CA 6V Transformador: 380V	NP2-EV53	●
		NP2-EV54	●
		NP2-EV55	●
		NP2-EV56	●

Dimensões (mm)

NP2-EV 6 □

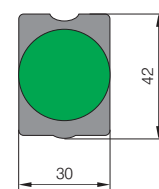
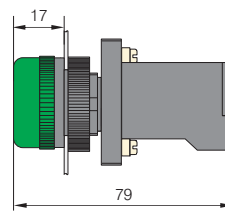
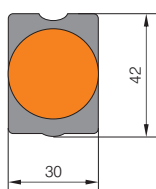
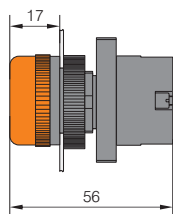

NP2-EV 4□





★ Indicador (compacto)

NP2-EV16 □□	Voltagem da Lâmpada	Modelo	Cor
	LED : CA 6V, 12V, 24V, 36V, 48V, 110V, 230V	NP2-EV161	○
		NP2-EV163	●
		NP2-EV164	●
		NP2-EV165	●
		NP2-EV166	●
	NEON : CA 110V, 230V, 400V	NP2-EV161	○
		NP2-EV163	●
		NP2-EV164	●
		NP2-EV165	●
		NP2-EV166	●
	INCANDESCENTE: CA 6V, 12V, 24V, 36V, 48V	NP2-EV161	○
		NP2-EV163	●
NP2-EV164		●	
NP2-EV165		●	
NP2-EV166		●	

★ Botões Seletores (2 posições)-(Não-iluminado)

NP2-ED (J, G) □□	Metal	Botões Seletores	↵	↶
	NP2-ED21	↵	1	—
	NP2-ED22		—	1
	NP2-ED23		2	—
	NP2-ED24		—	2
	NP2-ED25		1	1
	NP2-ED41	↶	1	—
	NP2-ED42		—	1
	NP2-ED43		2	—
	NP2-ED44		—	2
	NP2-ED45		1	1
	NP2-EJ21	↵	1	—
	NP2-EJ22		—	1
	NP2-EJ23		2	—
	NP2-EJ24		—	2
	NP2-EJ25		1	1
	NP2-EJ41	↶	1	—
	NP2-EJ42		—	1
	NP2-EJ43		2	—
	NP2-EJ44		—	2
	NP2-EJ45		1	1

★ Botões Seletores (3 posições)-(Não-iluminado)

NP2-ED (J, G) □□	Metal	Botões Seletores	↵	↶
	NP2-ED31	↵	1	—
	NP2-ED32		—	1
	NP2-ED33		2	—
	NP2-ED34		—	2
	NP2-ED35		1	1
	NP2-ED51	↶	1	—
	NP2-ED52		—	1
	NP2-ED53		2	—
	NP2-ED54		—	2
	NP2-ED55		1	1
	NP2-EJ31	↵	1	—
	NP2-EJ32		—	1
	NP2-EJ33		2	—
	NP2-EJ34		—	2
	NP2-EJ35		1	1
	NP2-EJ51	↶	1	—
	NP2-EJ52		—	1
	NP2-EJ53		2	—
	NP2-EJ54		—	2
	NP2-EJ55		1	1

★ Botões Seletores (2 posições)-(Não-iluminado)

NP2-ED (J, G) □□	Metal	Botões Seletores	↖ ↗	
			↖	↗
	NP2-EG21		1	—
	NP2-EG22		—	1
	NP2-EG23		2	—
	NP2-EG24		—	2
	NP2-EG25	1	1	
	NP2-EG41		1	—
	NP2-EG42		—	1
	NP2-EG43		2	—
	NP2-EG44		—	2
	NP2-EG45	1	1	
	NP2-EG21B		1	—
	NP2-EG22B		—	1
	NP2-EG23B		2	—
	NP2-EG24B		—	2
	NP2-EG25B		1	1

★ Botões Seletores (3 posições)-(Não-iluminado)

NP2-ED (J, G) □□	Metal	Botões Seletores	↖ ↗	
			↖	↗
	NP2-EG31		1	—
	NP2-EG32		—	1
	NP2-EG33		2	—
	NP2-EG34		—	2
	NP2-EG35	1	1	
	NP2-EG51		1	—
	NP2-EG52		—	1
	NP2-EG53		2	—
	NP2-EG54		—	2
	NP2-EG55	1	1	
	NP2-EG31D		1	—
	NP2-EG32D		—	1
	NP2-EG33D		2	—
	NP2-EG34D		—	2
	NP2-EG35D		1	1

Dimensões (mm)

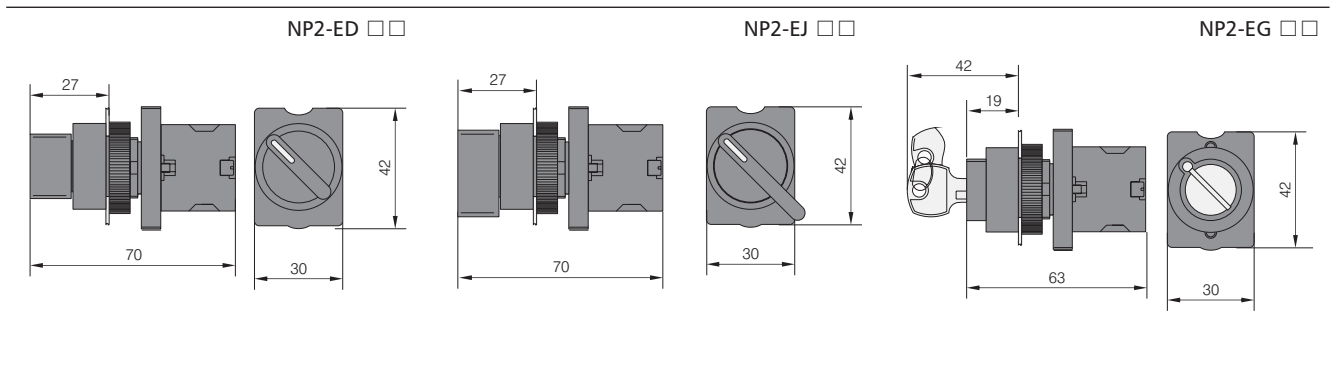

Cabeça

★ Botão Embutido Temporário (Não-iluminado)

NP2-BA □	Metal	Especificações
	NP2-BA1	○
	NP2-BA2	●
	NP2-BA3	●
	NP2-BA4	●
	NP2-BA5	●
	NP2-BA6	●

NP2-EA □	Plástico	Especificações
	NP2-EA1	○
	NP2-EA2	●
	NP2-EA3	●
	NP2-EA4	●
	NP2-EA5	●
	NP2-EA6	●

★ Botão Embutido Temporário -(Iluminado)

NP2-BW3 □	Metal	Especificações
	NP2-BW31	○
	NP2-BW33	●
	NP2-BW34	●
	NP2-BW35	●
	NP2-BW36	●

NP2-EW3 □	Plástico	Especificações
	NP2-EW31	○
	NP2-EW33	●
	NP2-EW34	●
	NP2-EW35	●
	NP2-EW36	●

★ Botão de cabeça dupla-(Não-iluminado)

NP2-BL □□□	Metal	Especificações
	NP2-BL832	Botão embutido
	NP2-BL842	Botão embutido + botão destacado

NP2-EL □□□	Plástico	Especificações
	NP2-EL832	Botão embutido
	NP2-EL842	Botão embutido + botão destacado

★ Botão de cabeça dupla-(Iluminado)

NP2-BW □□	Metal	Especificações
	NP2-BW84	Botão embutido + botão destacado



NP2-EW □□	Plástico	Especificações
	NP2-EW84	Botão embutido + botão destacado





★ Luz indicadora

NP2-BV/ □	Metal	Especificações
	NP2-BV/1	○
	NP2-BV/3	●
	NP2-BV/4	●
	NP2-BV/5	●
	NP2-BV/6	●

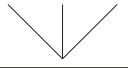
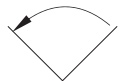
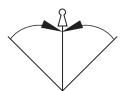

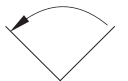

NP2-EV/ □	Plástico	Especificações
	NP2-EV/1	○
	NP2-EV/3	●
	NP2-EV/4	●
	NP2-EV/5	●
	NP2-EV/6	●



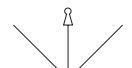
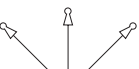

★ Cabeça do Botão Seletor-(Não-iluminado)

NP2-BV/ □	Metal	Especificações
	NP2-BD2	
	NP2-BD3	
	NP2-BD4	
	NP2-BD5	

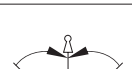
NP2-EV/ □	Plástico	Especificações
	NP2-ED2	
	NP2-ED3	
	NP2-ED4	
	NP2-ED5	

★ Cabeça do Botão Seletor com Chave-(Não-iluminado)

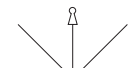
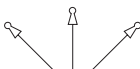
NP2-BG □	Metal	Especificações
	NP2-BG2	
	NP2-BG2B	
	NP2-BG3	
	NP2-BG3D	
	NP2-BG4	
	NP2-BG5	

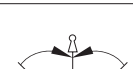

NP2-EG □	Plástico	Especificações
	NP2-EG2	
	NP2-EG2B	
	NP2-EG3	
	NP2-EG3D	
	NP2-EG4	
	NP2-EG5	

★ Suporte

NP2-BZ009	Metal	Especificações
	NP2-BZ009	Para NP2-B □ □



NP2-EZ009	Plástico	Especificações
	NP2-EZ009	Para NP2-E □ □



★ Rótulo de Advertência

NP2-BY	Metal	Especificações
	NP2-BY9101	φ 60 (vazio)
	NP2-BY9330	φ 60 (impresso)
	NP2-BY8101	φ 90 (vazio)
	NP2-BY8330	φ 90 (impresso)



NP2-BZ	Metal	Especificações
	NP2-BZ31	30mm (A) X45mm (L)

★ Caixa da cabeça do Botão de apertar-(à prova d'água)



	Especificações
	Para NP2-BP
	Para NP2-BA (EA)

	Especificações
	Para NP2-BL (EL) 832
	Para NP2-BL (EL) 842

★ Bloco de contato

NP2-BE □□□	Metal	Especificações
	NP2-BE101	SEM Contato
	NP2-BE102	SEM Contato

★ Base para Iluminado (sem lâmpada)

NP2-EW □/EV □	Metal	Especificações
	NP2-EW6/EV6	Tipo direto
	NP2-EW4/EV4 220V	Tipo do transformador
	NP2-EW5/EV5 400V	

★ Lâmpada (Incandescente)

BA9s	Especificações
	CA/CC 6V
	CA/CC 12V
	CA/CC 24V
	CA/CC 36V
	CA/CC 48V

★ Lâmpada (Neon)

Neon Lamp	Especificações	
	CA/CC 110V	●
	CA/CC 110V	●
	CA/CC 220V	●
	CA/CC 220V	●
	CA/CC 380V	●
	CA/CC 380V	●

★ Lâmpada (LED)

BA9s	Especificações	
	CA/CC 6V	○
	CA/CC 6V	●
	CA/CC 6V	●
	CA/CC 6V	●
	CA/CC 6V	●
	CA/CC 6V	●
	CA/CC 12V	○
	CA/CC 12V	●
	CA/CC 12V	●
	CA/CC 12V	●
	CA/CC 12V	●
	CA/CC 12V	●
	CA/CC 24V	○
	CA/CC 24V	●
	CA/CC 24V	●
	CA/CC 24V	●
	CA/CC 24V	●
	CA/CC 24V	●
	CA/CC 24V	●
	CA/CC 36V	○
	CA/CC 36V	●
	CA/CC 36V	●
	CA/CC 36V	●
	CA/CC 48V	○
CA/CC 48V	●	
CA/CC 48V	●	
CA/CC 48V	●	

BA9s	Especificações	
	CA/CC 48V	●
	CA/CC 110V	○
	CA/CC 110V	●
	CA/CC 110V	●
	CA/CC 110V	●
	CA/CC 110V	●
	CA/CC 110V	●
	CA/CC 220V	○
	CA/CC 220V	●
	CA/CC 220V	●
	CA/CC 220V	●
	CA/CC 220V	●

★ Caixa

PIC	Modelo
	NP2-B01
	NP2-B02
	NP2-B03
	NP2-J01
	NP2-B101H29
	NP2-B102
	NP2-B103
	NP2-B111H29

★ Caixa

PIC	Modelo
	NP2-B112
	NP2-B114
	NP2-B132H29
	NP2-B142H29
	NP2-B164H29
	NP2-J174
	NP2-J174H29

★ Caixa

PIC	Modelo
	NP2-B211H29
	NP2-B213
	NP2-B215
	NP2-B222
	NP2-B223

★ Caixa

PIC	Modelo
	NP2-B311H29 (Avanço, Parada, Retrocesso)
	NP2-B321H29 (Para cima, Parada, Para baixo)
	NP2-B324

★ Caixa

PIC	Modelo
	NP2-B334
	NP2-B339
	NP2-B341H29 (Fecha, Para, Abre)
	NP2-B361H29 (Parada, Partida)

★ Caixa

PIC	Modelo
	NP2-B363
	NP2-B366